

Brookstone®

BIG BLUE POWER

INDOOR/OUTDOOR WIRELESS SPEAKER



IN THE BOX

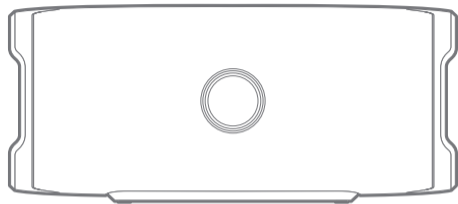

Wireless Speaker

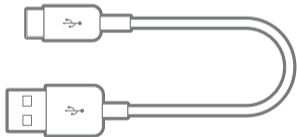

USB Type-C Cable



Dock



User Guide

LOCATION OF CONTROLS

FRONT

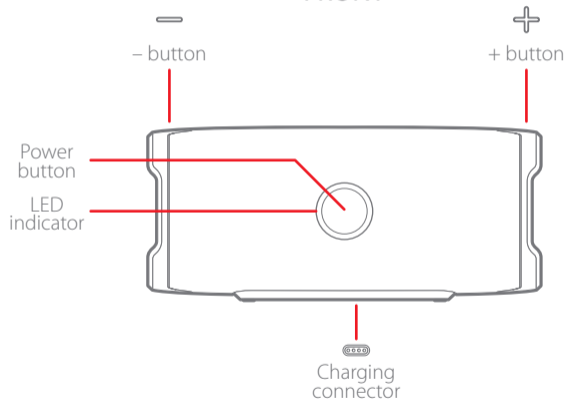

BACK

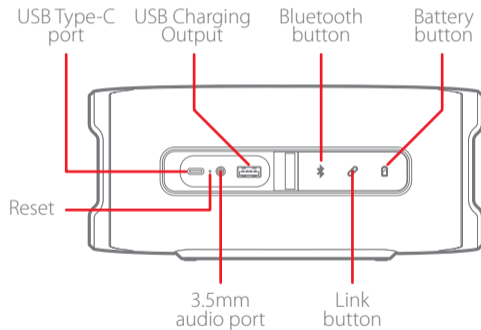

CHARGING

Charging with the USB Type-C Cable

Insert the USB Type-C cable into the speaker's USB port as shown below and connect the other end to any USB adaptor or charging device. The speaker's LED indicator will light up red while charging and turn off when fully charged.

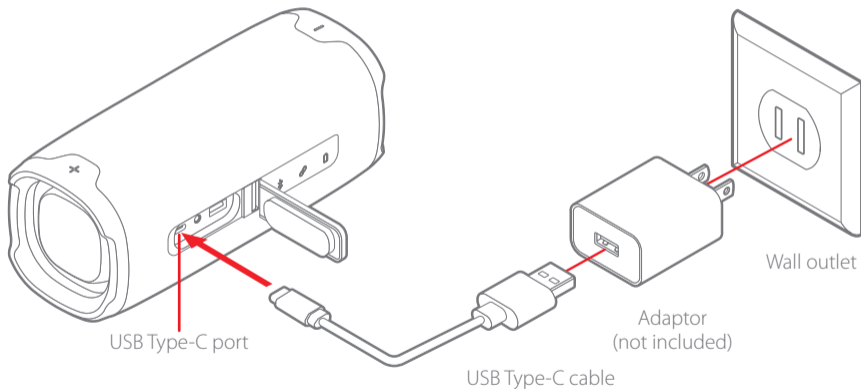

Note: When the battery is low, the speaker's LED indicator will flash red once every 10 seconds.

Charging with the Dock

1. Insert the USB Type-C cable into the dock's USB port as shown below and connect the other end to any USB adaptor or charging device.

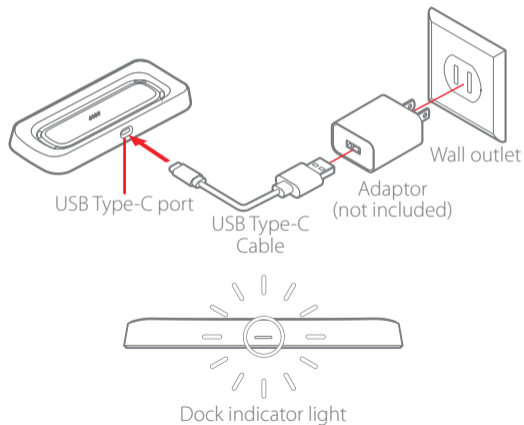

2. Place the speaker on the dock, the LED of the dock will light up white, indicating that the speaker is properly placed.
3. The speaker's LED indicator will light up red while charging and turn off when fully charged. The dock indicator light is always lit white when the speaker is properly docked, regardless if the speaker is fully charged or not.

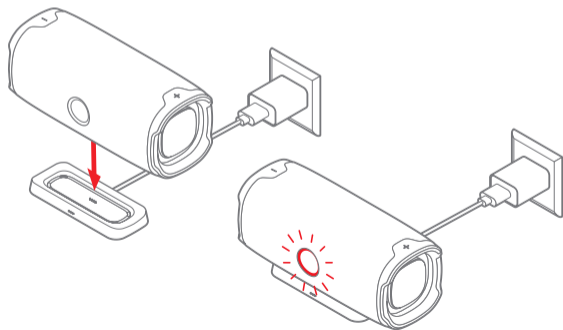

POWER BUTTON

The Power button is used to power the speaker on/off or play/pause your music.

Please see instructions below explaining the correct way to use the Power button:

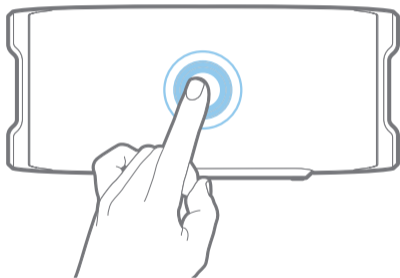

Correct

Gently touch the Power button

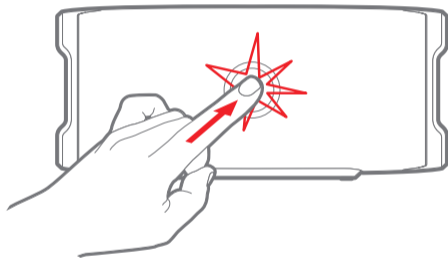

Incorrect

Don't push down on the Power button

POWER ON/OFF

Power On

Touch and **HOLD** the Power button for 3 seconds until the speaker powers on.

Power Off

Touch and **HOLD** the Power button for 3 seconds until the speaker's LED indicator turns off.

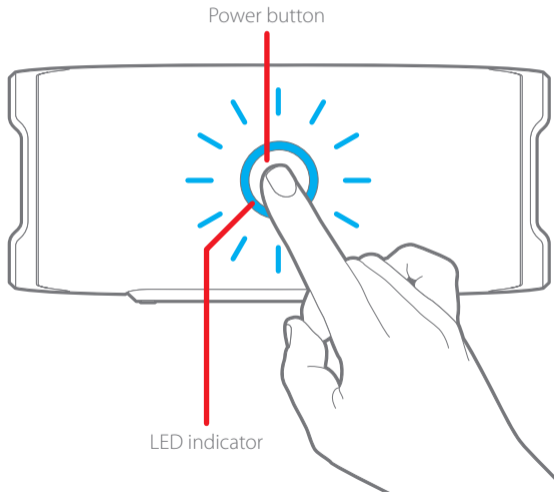

BLUETOOTH PAIRING AND CONNECTING

Connecting

1) While powered on, press the Bluetooth button and the speaker's LED will slowly flash blue indicating that the speaker is in Bluetooth pairing mode.

Bluetooth Profile: A2DP V1.3, AVRCP V1.6

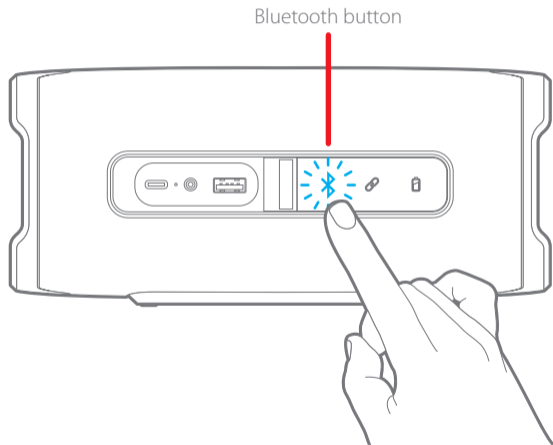

2. Open your device's Bluetooth menu and find **Brookstone BKS550** and select it to pair.
3. Once paired, the voice prompt "Connected" will be heard and the speaker's LED indicator will turn solid blue.

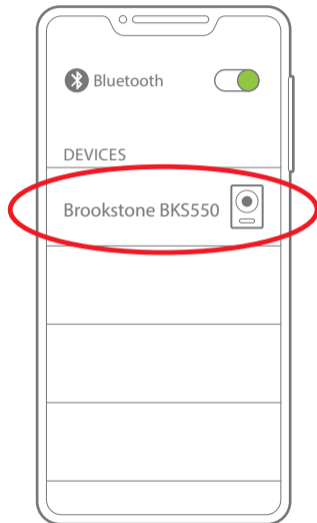
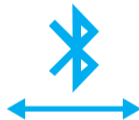
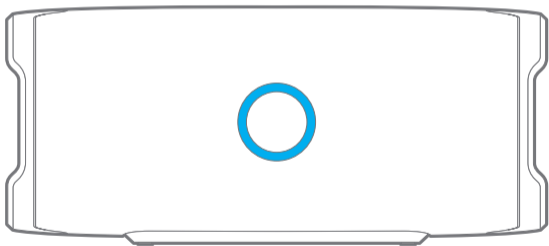

Disconnecting

Press the Bluetooth button on the back of the speaker to disconnect it from the device. Once it disconnects, you'll hear the voice prompt "Disconnected" and it will go into pairing mode. The speaker's LED indicator will slowly flash blue.

Note: This feature is handy to quickly pair the speaker to a new device.

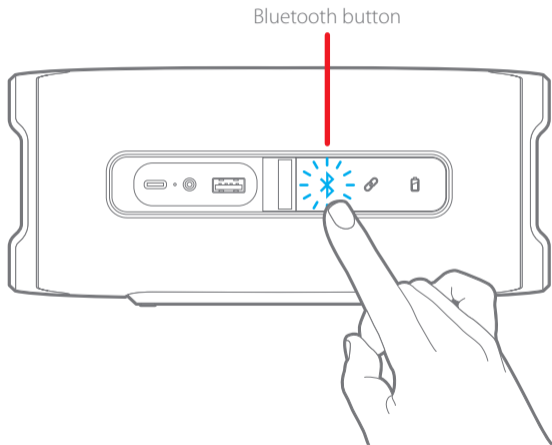

SPEAKER PLACEMENT

Place the speaker as shown below, on a flat and stable surface.

Preferred

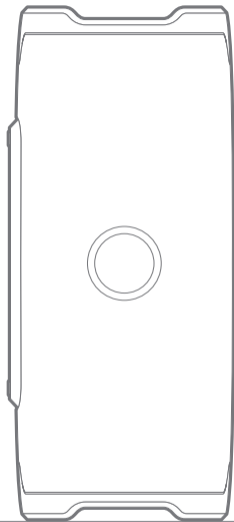
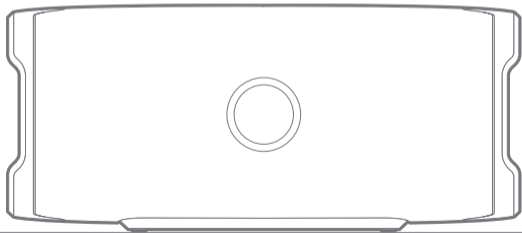

PLAY MUSIC

Play/Pause:

Tap the Power button to play/pause music.

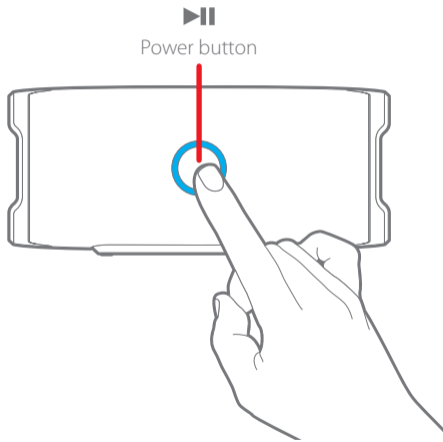

Volume controls:

Tap the Volume +/- button to change the volume.

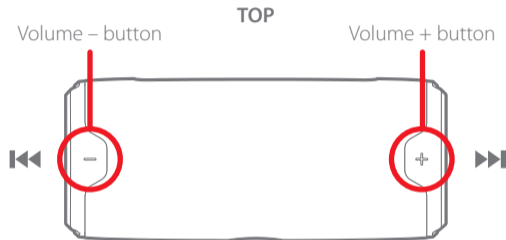

Next/Previous track:

Touch and **HOLD** the Volume + button to go to the next track, and touch and **HOLD** the Volume - button to go back to the previous track*.

*The support of this feature depends on the music player used.

LINKING THE SECOND SPEAKER

You can link two Brookstone Big Blue Power speakers to create a TWS (true wireless) pairing. Before beginning the linking process, make sure one of the speakers is already paired to a Bluetooth enabled device (see page 7). We will refer to that speaker as **Speaker 1** and the other speaker as **Speaker 2**.

1. Press and HOLD the "Link" button of either speaker until you hear the "Linking" voice prompt and the LED indicator of that speaker starts quickly flashing white. Repeat the process for the other speaker.

Speaker 1

Link button

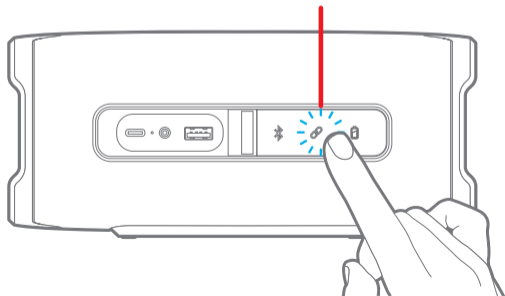

Speaker 2

Link button

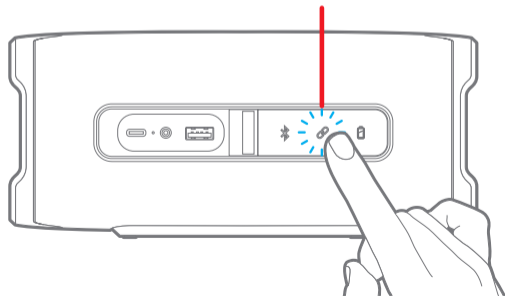

2. Once the speakers are linked, you'll hear the "Speaker Linked" voice prompt and the LED indicator of **Speaker 1** will turn solid blue while **Speaker 2** will be solid white.



Speaker 1

The main speaker that is connected to a Bluetooth enabled device and which is used as the audio source.

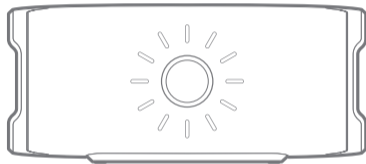

Speaker 2

The additional speaker that is linked to the main speaker.

Note: When the speakers are linked, right and left channels are created for a true stereo experience.

Unlinking the speakers

Press the "Link" button of either speaker to unlink them. The LED indicator of **Speaker 1** will remain solid blue while **Speaker 2** will slowly flash white.



Disconnect a device from linked speakers

Press the "Bluetooth" button of **Speaker 1** and you will hear the voice prompt "Disconnected" and the LED indicator of that speaker will slowly flash blue. You can now connect that speaker to another device.

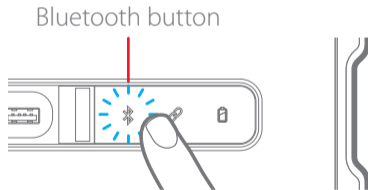

BATTERY INDICATOR

Battery button

Press the battery button on the back of the speaker to know the current battery level.

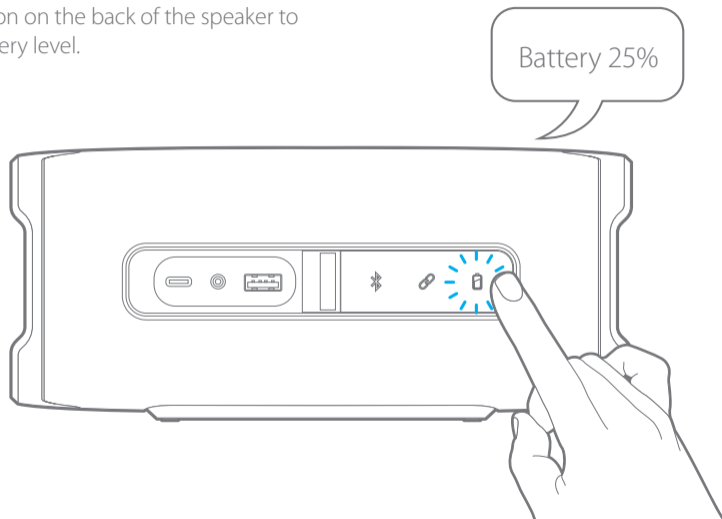

POWER BANK

While on the go, use the Big Blue Power speaker as a power bank.

Use the “USB Charging Output” port as shown below to charge your devices.

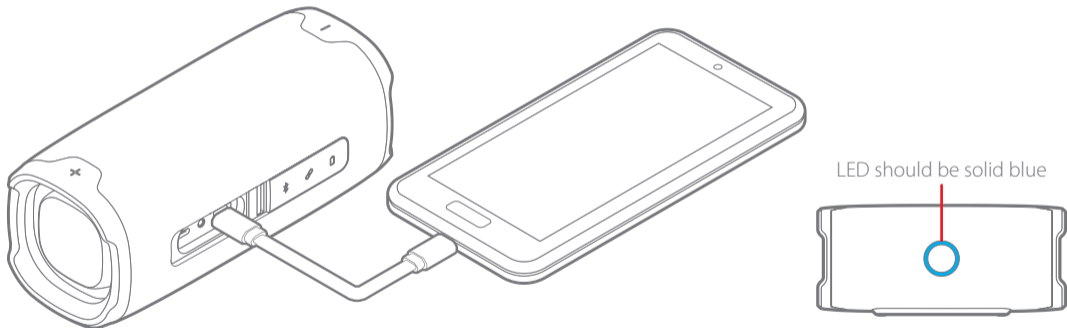

Note: While using the speaker as a power bank, make sure it's connected to any device via Bluetooth (the speaker's LED will be solid blue) – otherwise its battery saving feature will power off the speaker after 15 minutes.

FACTORY RESET

Press and **HOLD** the Bluetooth and Link buttons for 5 seconds. The LED of the Power button will flash WHITE 3 times, and then the speaker will enter the pairing mode and the LED of the Power button will flash BLUE.

Reset hole



If some of the buttons don't work, insert a pin into the Reset hole for 2 seconds to turn off the speaker.

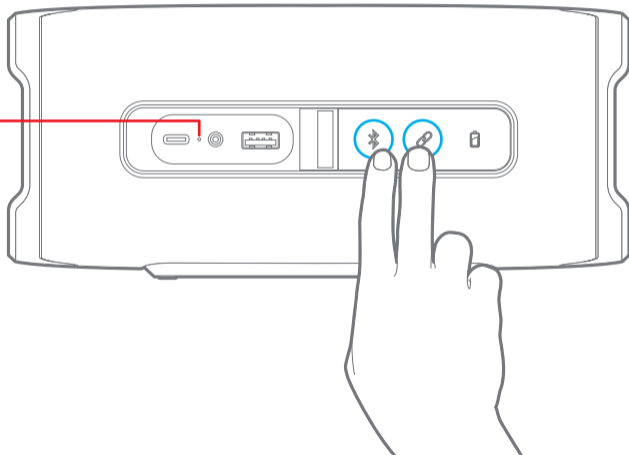

WATERPROOF RATING – IPX7

- This speaker has an ingress protection rating of 7 (IPX7). This means it can be completely submerged in water for up to 30 minutes at a depth of 1 meter.
- The protective rubber seal needs to completely cover the speaker's input panel to protect it from water damage.
- Dry the speaker off completely before charging or using the AUX inputs.
- Do NOT charge near sources of water or wet areas.

BEFORE EXPOSING TO WATER:

- REMOVE ALL CABLES CONNECTED TO THE SPEAKER
- MAKE SURE THE PORTS COVER IS SEALED TIGHTLY
- DO NOT EXPOSE TO WATER WHILE CHARGING

FCC INFORMATION

This device complies with Part 15 of the FCC Rules. Operation is subject to the following two conditions: (1) this device may not cause harmful interference, and (2) this device must accept any interference received, including interference that may cause undesired operation.

Warning: Changes or modifications to this unit not expressly approved by the party responsible for compliance could void the user's authority to operate the equipment.

NOTE: This equipment has been tested and found to comply with the limits for a Class B digital device, pursuant to Part 15 of the FCC Rules. These limits are designed to provide reasonable protection against harmful interference in a residential installation. This equipment generates, uses and can radiate radio frequency energy and, if not installed and used in accordance with the instructions, may cause harmful interference to radio communications. However, there is no guarantee that interference will not occur in a particular installation. If this equipment does cause harmful interference to radio or television reception, which can be determined by turning the equipment off and on, the user is encouraged to try to correct the interference by one or more of the following measures:

- Reorient or relocate the receiving antenna.
- Increase the separation between the equipment and receiver.
- Connect the equipment into an outlet on a circuit different from that to which the receiver is connected.
- Consult the dealer or an experienced radio/ TV technician for help

Information Regarding Exposure to Radio Frequency Energy





Your device is designed and manufactured not to exceed the emission limits for exposure to RF energy set by the Federal Communications Commission of the United States (FCC). Information on your Device is on file with the FCC and can be found under the Display Grant section of <http://www.fcc.gov/oet/ea/> after searching on the FCC ID for your Device, which can be found on the back of the Device.

LITHIUM POLYMER BATTERY WARNINGS

This device contains a non-removable Lithium-Polymer battery. The battery must be recycled or disposed of properly. Contact your local waste management office for information on battery recycling or disposal.



Rating Label Definitions

-  Direct current symbol.
-  This symbol signifies the product must not be discarded as household waste, and should be delivered to an appropriate collection facility for recycling. Proper disposal and recycling helps protect natural resources, human health and the environment.
-  This symbol signifies and declares that this equipment has battery charging which complies with California CEC and energy efficiency.
-  This symbol signifies that this is a wireless device powered by Bluetooth® technology. The Bluetooth® word mark and logos are registered trademarks owned by Bluetooth SIG, Inc., used under license.

LIMITED WARRANTY

1-Year Limited Warranty **Territory: United States/Canada**

LIMITED WARRANTY TO ORIGINAL CONSUMER

This product (including any accessories included in the original packaging) as supplied and distributed new by an authorized retailer is warranted by Southern Telecom, Inc. to the original consumer purchaser against defects in materials and workmanship ("Warranty") as follows:

To obtain warranty service:

- Visit our website at www.southerntelecom.com
- Click on Product Support
- Select the Brand of your device
- Select Service Request and fill out the form to begin your inquiry

Or call the Customer Support number below:

1-877-668-4839 (Toll Free)

Monday - Friday: 8AM - 10PM (EST)

Your product will be repaired or replaced, at our option, for the same or similar model of equal value if examination by the service center determines this product is defective. Products received damaged as a result of shipping will require you to file a claim with the carrier.

Warranty service not provided

This warranty does not cover damage resulting from accident, misuse, abuse, improper installation or operation, lack of reasonable care, unauthorized modification including software modifications such as the installation of custom firmware. This warranty is voided in the

event any unauthorized person opens, alters or repairs this product. All products being returned to the authorized service center for repair must be suitably packaged.

NO WARRANTIES, WHETHER EXPRESS OR IMPLIED, INCLUDING, BUT NOT LIMITED TO, ANY IMPLIED WARRANTIES OF MERCHANTABILITY OR FITNESS FOR A PARTICULAR PURPOSE, OTHER THAN THOSE EXPRESSLY DESCRIBED ABOVE SHALL APPLY. DISTRIBUTOR FURTHER DISCLAIMS ALL WARRANTIES AFTER THE EXPRESS WARRANTY PERIOD STATED ABOVE. NO OTHER EXPRESS WARRANTY OR GUARANTY GIVEN BY ANY PERSON, FIRM OR ENTITY WITH RESPECT TO THE PRODUCT SHALL BE BINDING ON DISTRIBUTOR. REPAIR, REPLACEMENT, OR REFUND OF THE ORIGINAL PURCHASE PRICE - AT DISTRIBUTOR'S SOLE DISCRETION - ARE THE EXCLUSIVE REMEDIES OF THE CONSUMER. IN NO EVENT WILL DISTRIBUTOR OR ITS MANUFACTURERS BE LIABLE FOR ANY INCIDENTAL, DIRECT, INDIRECT, SPECIAL, PUNITIVE OR CONSEQUENTIAL DAMAGES (SUCH AS, BUT NOT LIMITED TO, DAMAGES FOR LOSS OF PROFITS, BUSINESS, SAVINGS, DATA OR RECORDS) CAUSED BY THE USE, MISUSE OR INABILITY TO USE THE PRODUCT. EXCEPT AS STATED HEREIN, NO OTHER WARRANTIES SHALL APPLY. NOTWITHSTANDING THE FOREGOING, CONSUMER'S RECOVERY AGAINST DISTRIBUTOR SHALL NOT EXCEED THE PURCHASE PRICE OF THE PRODUCT SOLD BY DISTRIBUTOR. THIS WARRANTY SHALL NOT EXTEND TO ANYONE OTHER THAN THE ORIGINAL CONSUMER WHO PURCHASED THE PRODUCT AND IS NOT TRANSFERABLE.

Some countries, states or provinces do not allow the exclusion or limitation of incidental or consequential damages or allow limitations on warranties, so limitation or exclusions may not apply to you. This warranty gives you specific legal rights, and you may have other rights that vary from state to state or province to province. Contact your authorized retailer to determine if another warranty applies.

All product names, trademarks, and registered trademarks are property of their respective owners. All company, product, and service names used in this document are for identification purposes only. Use of these names, trademarks, and brands does not imply endorsement.

The Bluetooth® word mark and logos are registered trademarks owned by Bluetooth SIG, Inc., used under license.

Brookstone® trademark, name and logos are trademarks of BKST Brand Holdings LLC and used under license. Manufactured and Marked by Southern Telecom, Inc. under license.

Southern Telecom, Inc.
Brooklyn, NY 11220

Model: BKS550

Printed in China

v1.0 08-2019